

Colouring Techniques

Francesco
GROUP

beautiful **hair**

www.francescogroup.co.uk



Contents

Vertical 1/4 Head

Vertical 1/2 Head

Vertical 3/4 Head

Vertical Full Head

8 Section Octava / 16 Section Carousel

Icicle

Lightening

Trillian Dimension

Directional Barcoding

Francesco
GROUP

beautiful **hair**

www.francescogroup.co.uk

Weave temples - Weave/slice top

min 24 foils
max 29 foils

Verticle 1/4 Head

max time 30 mins
book back approx 1 hour

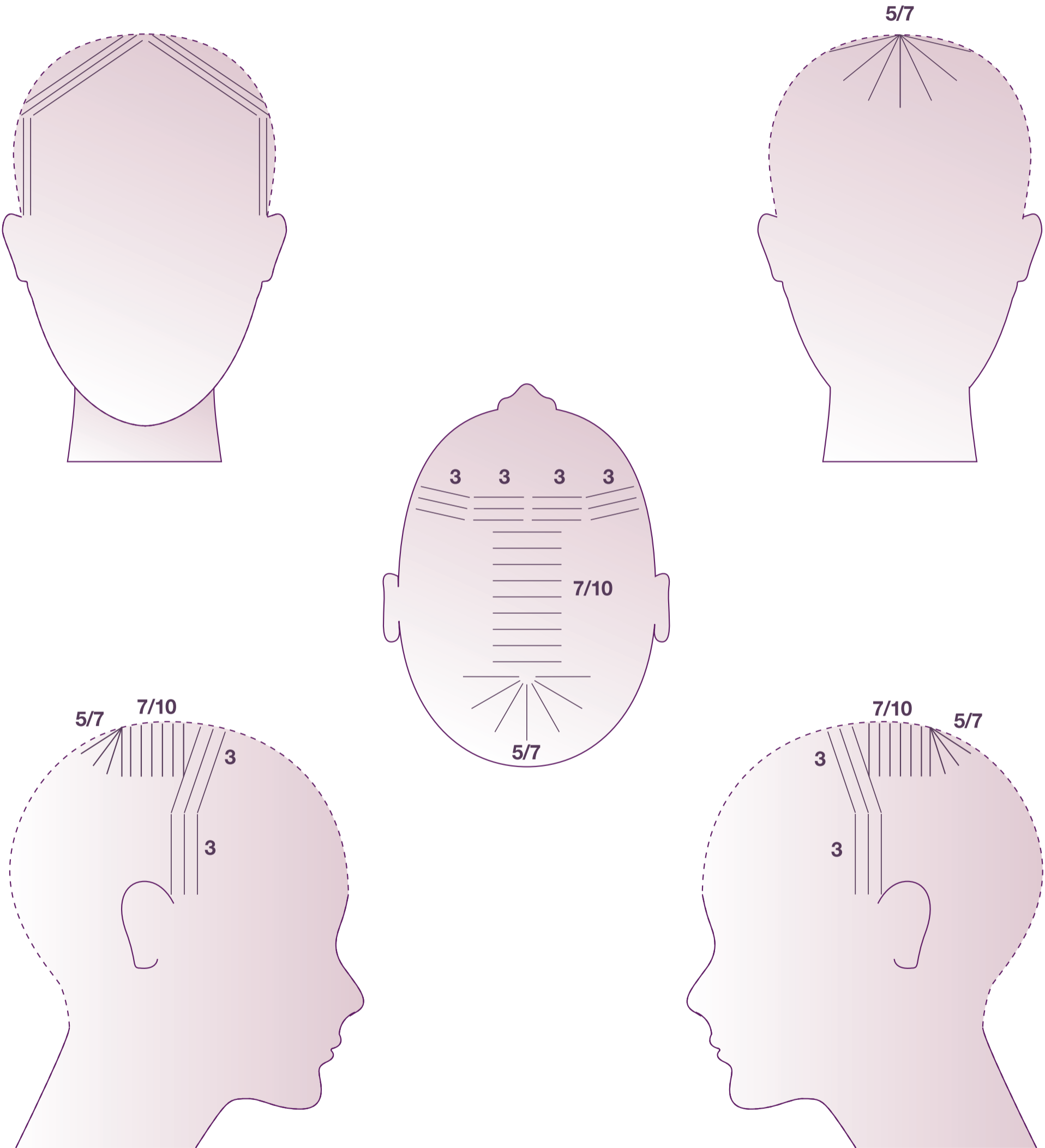

Francesco
GROUP

beautiful hair

www.francescogroup.co.uk

Gives individual highlight result

min 32 foils
max 36 foils

max time 45mins

book back approx 1 hour 30 mins

Vertical 1/2 Head

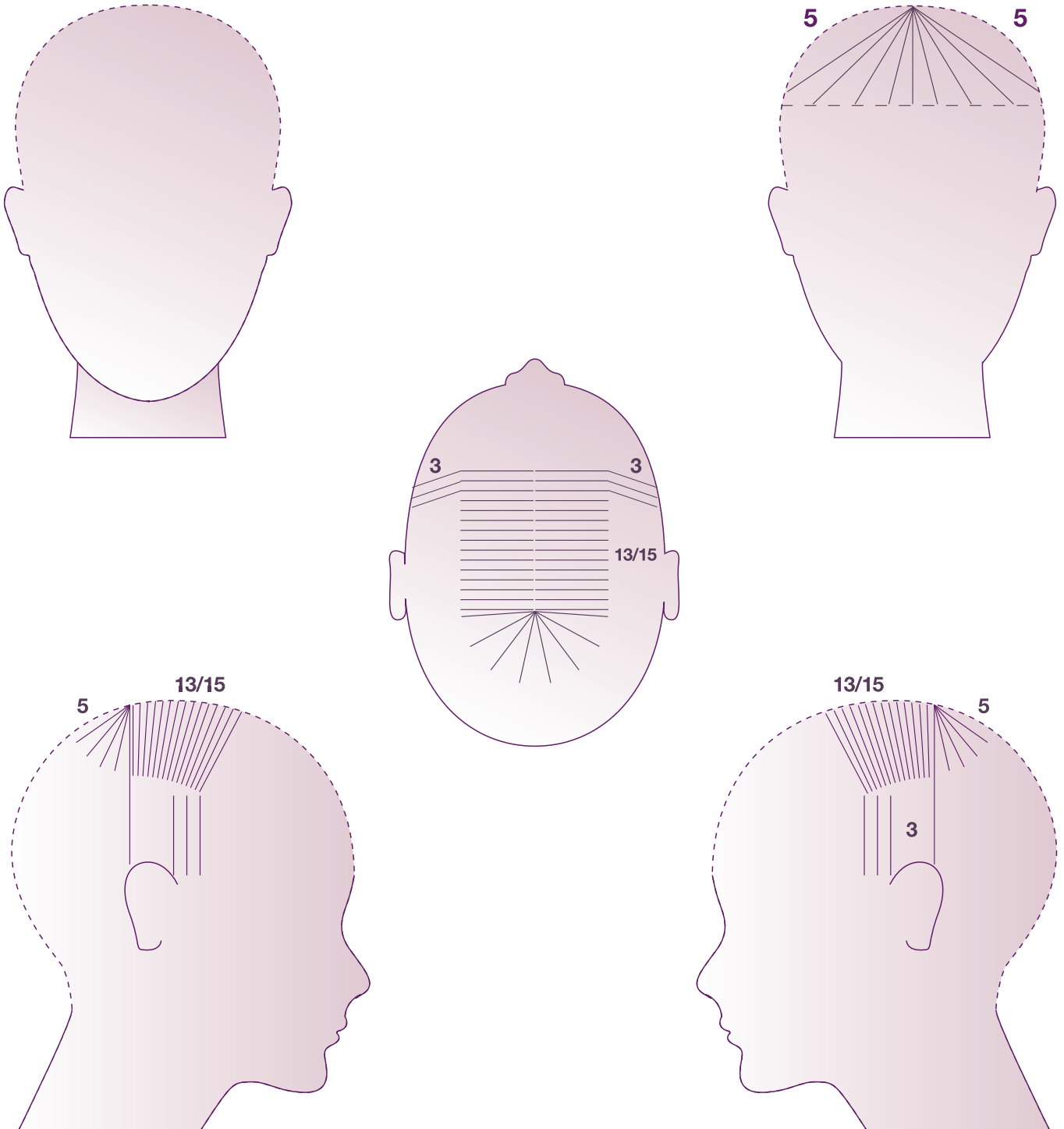

min 72 foils
max 84 foils

Vertical 3/4 Head

max time 1 hour
book back approx 1 hour 45 mins

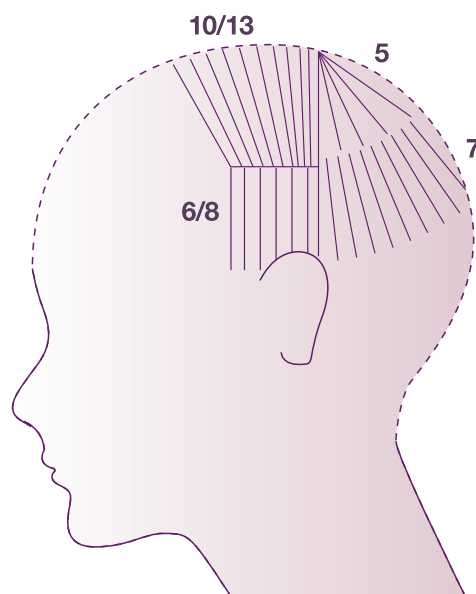
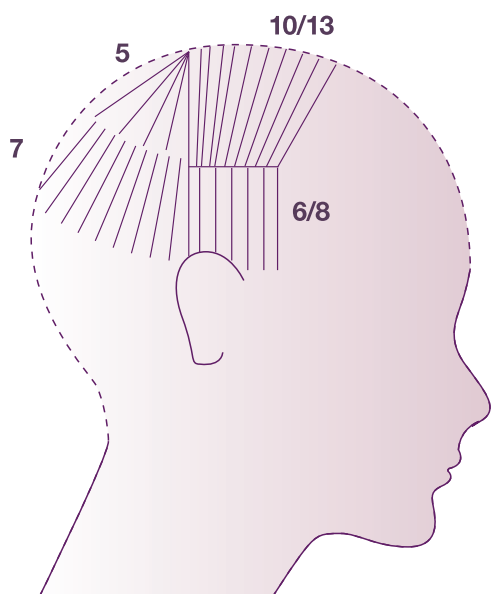
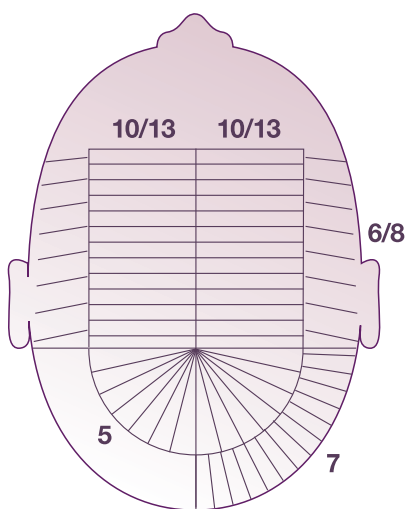
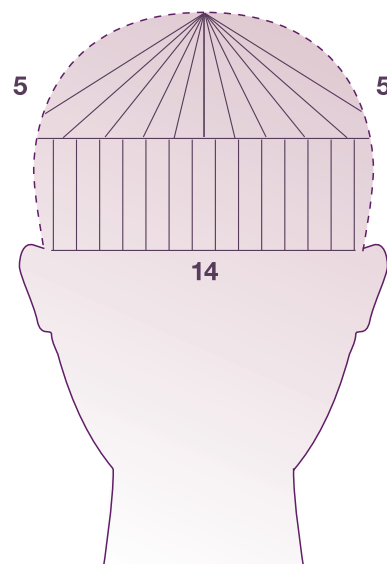
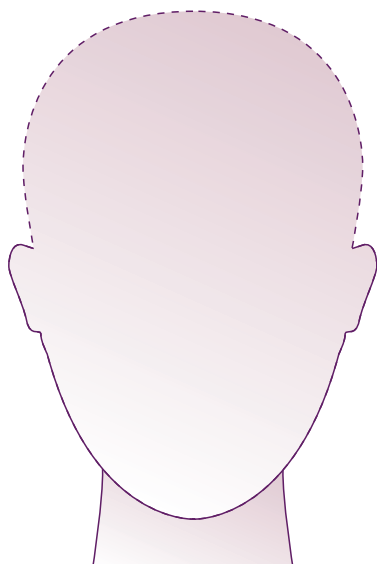

min 82 foils
max 96 foils

Vertical Full Head

max time 1 hour 15 mins
book back approx 2 hours

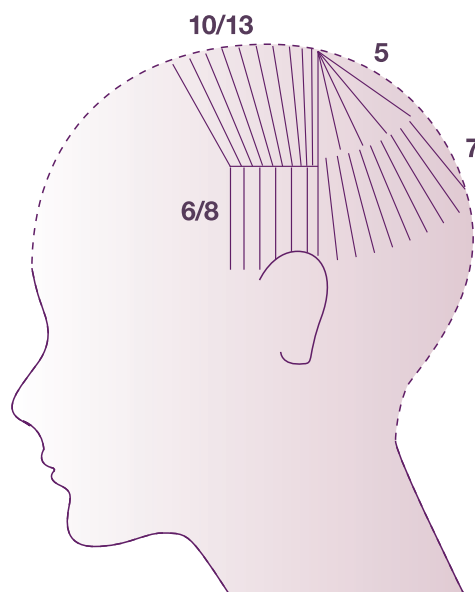
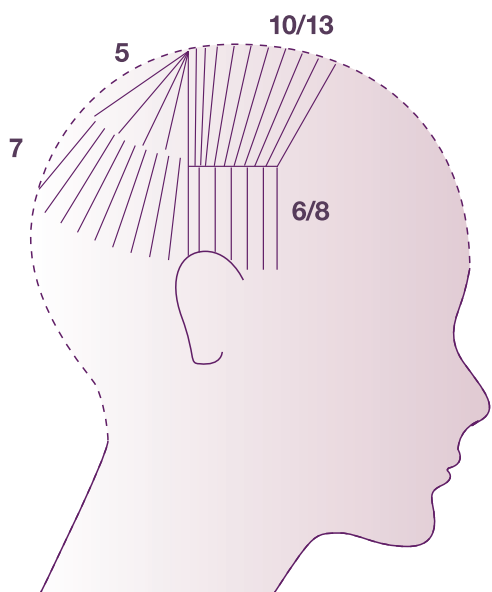
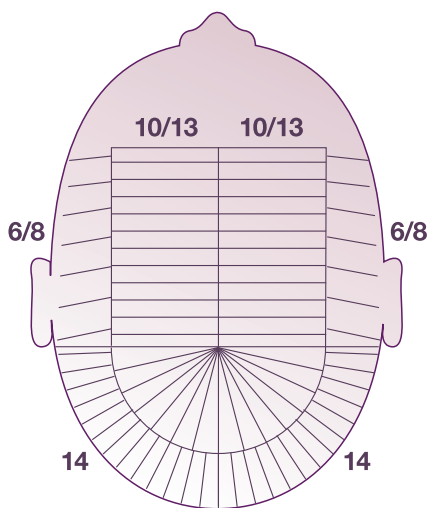
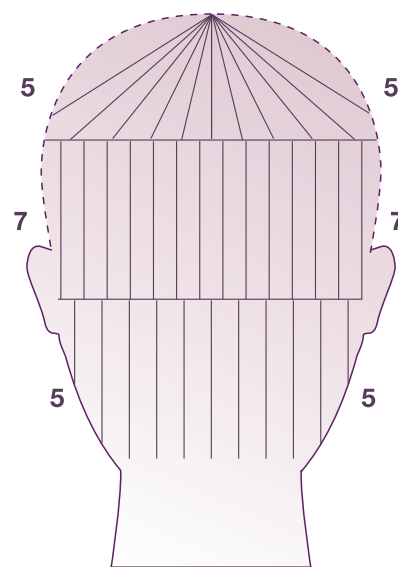
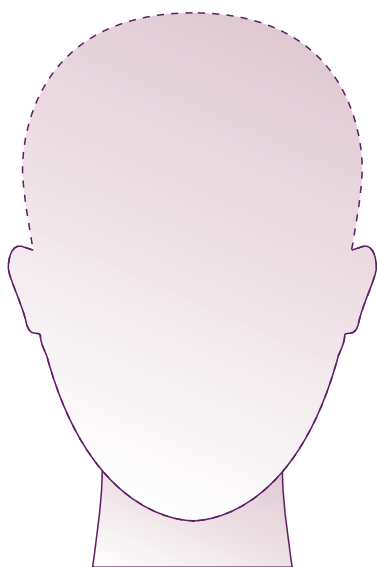

8 Section Octáva

or turn into 16 Section Carousel

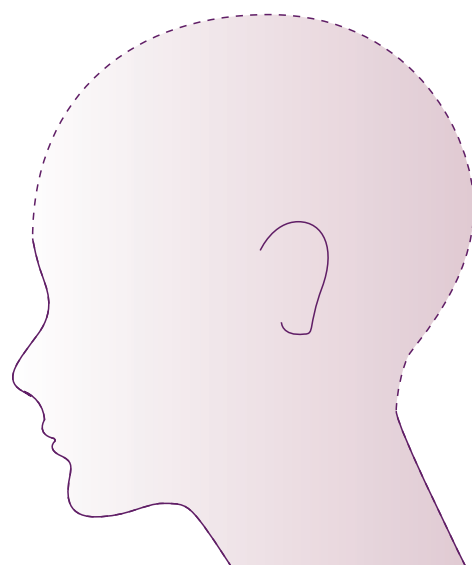
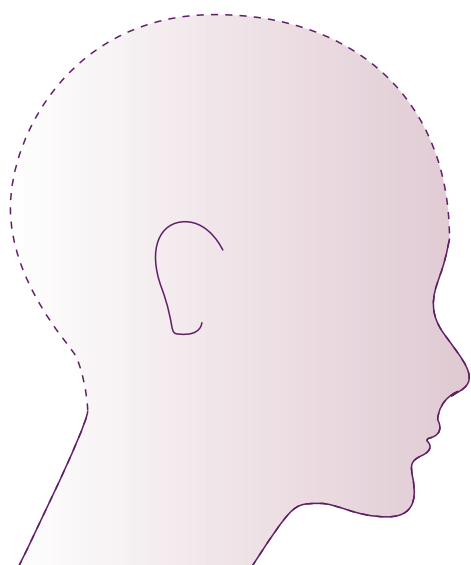
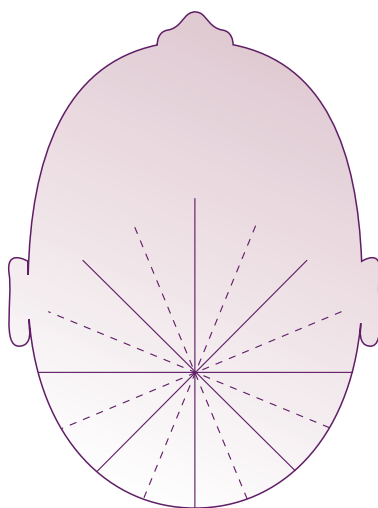
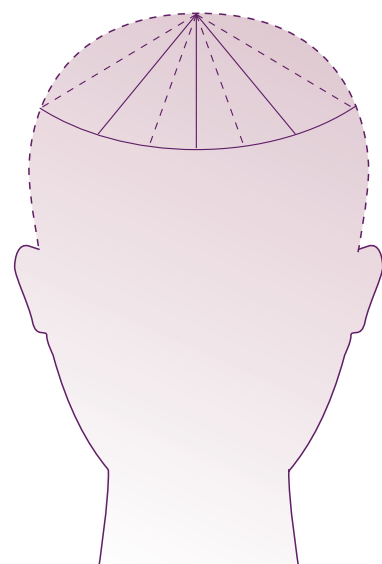
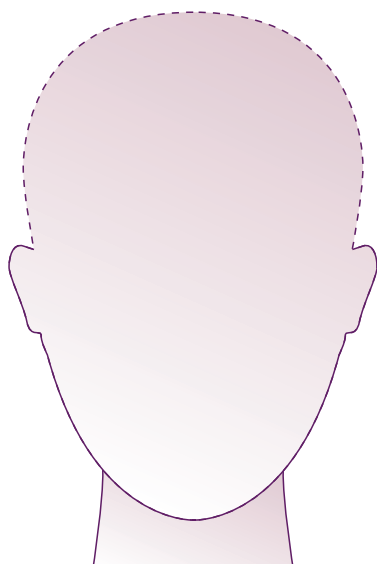





Francesco
GROUP

beautiful **hair**

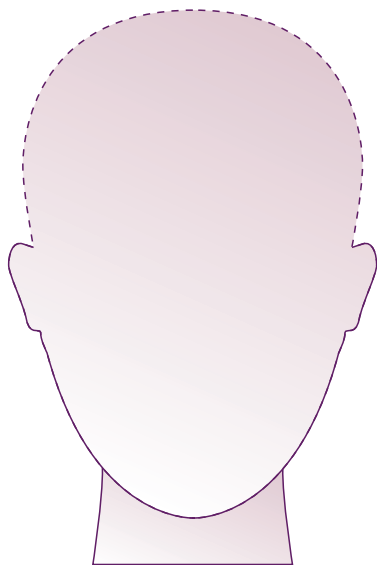
www.francescogroup.co.uk

Icicle



small of point one colour 
rest another colour 
back colour for rest 

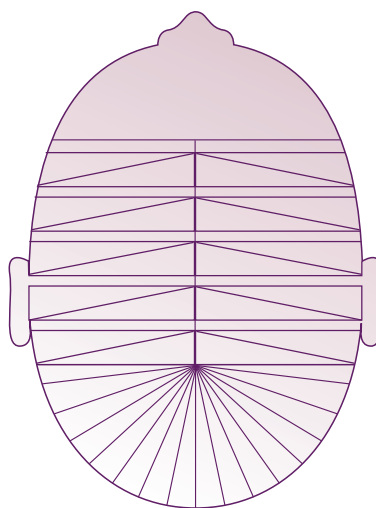
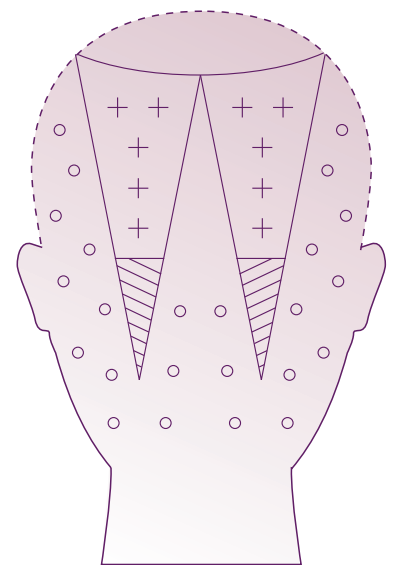

 fine slice, thick section split into triangles (fine to thick!) corner to corner

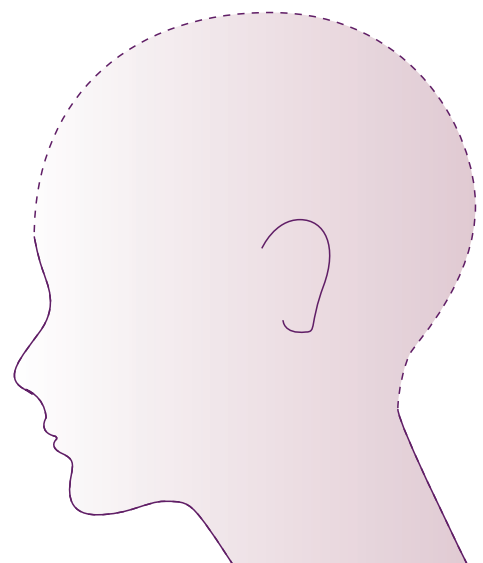
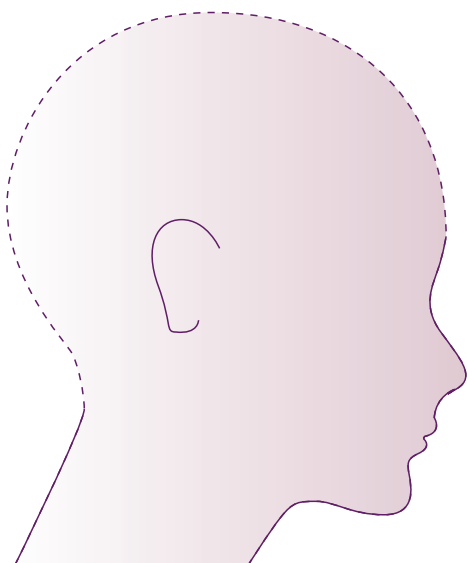

Lightening

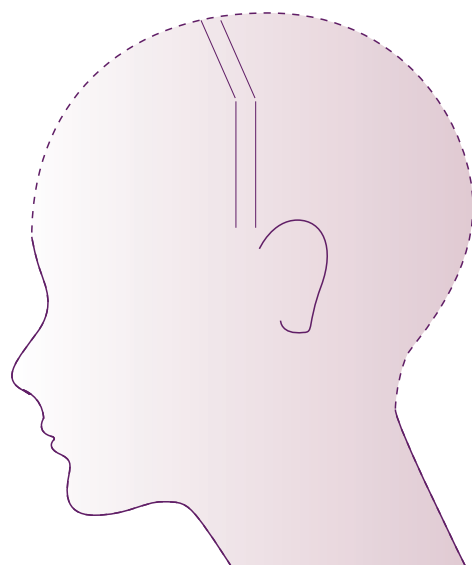
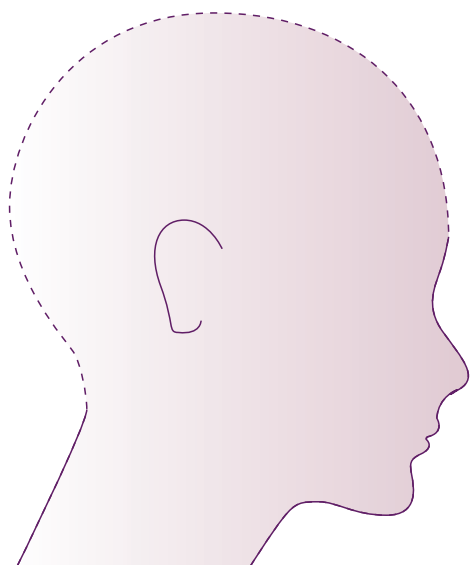
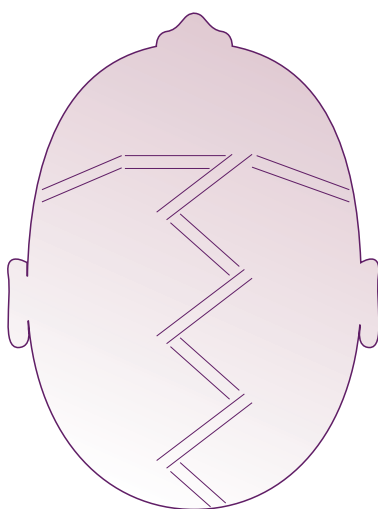
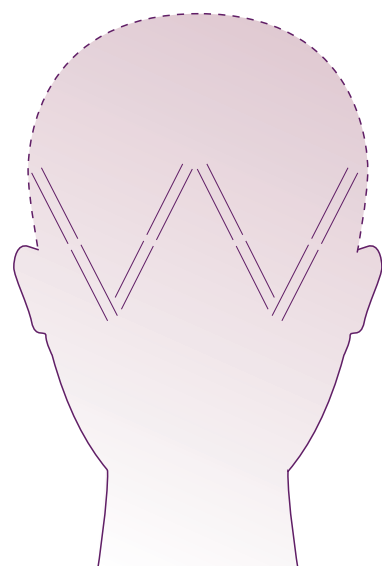
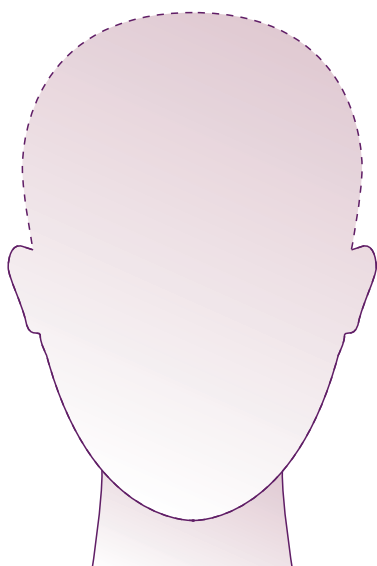

Trillian Dimension

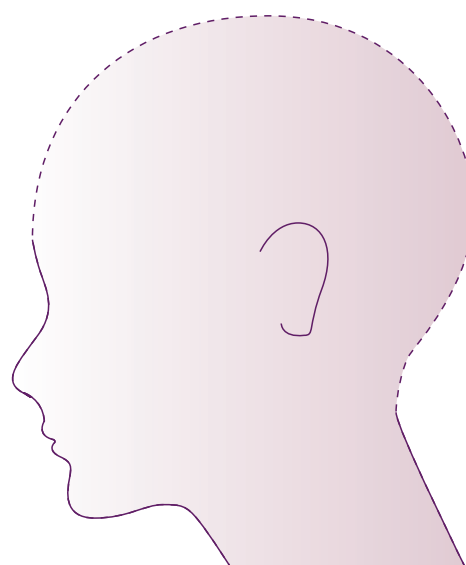
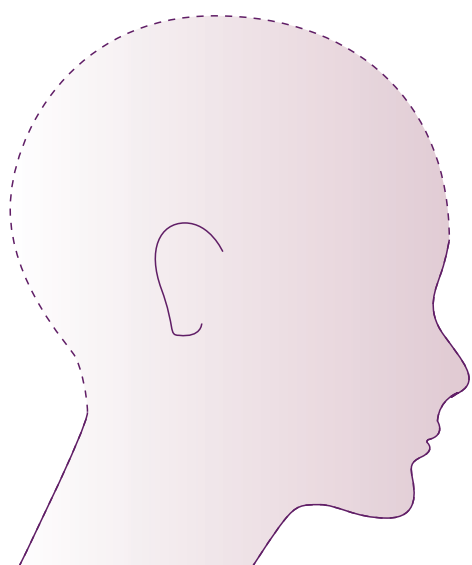
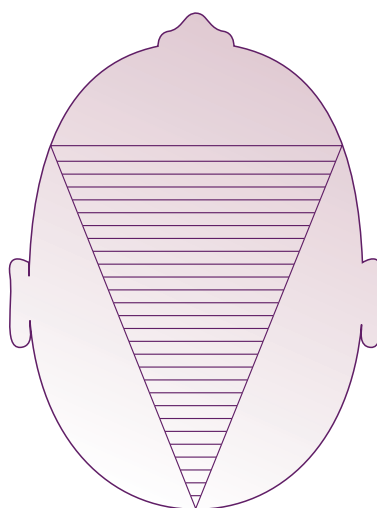
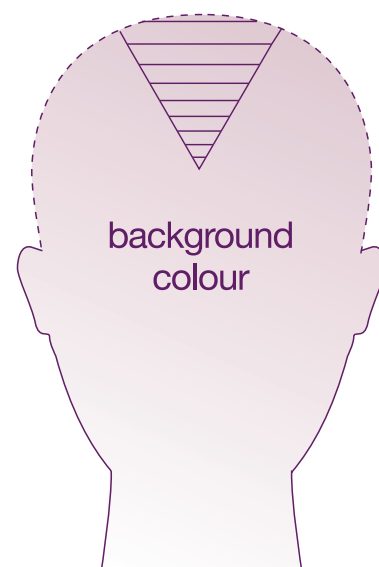
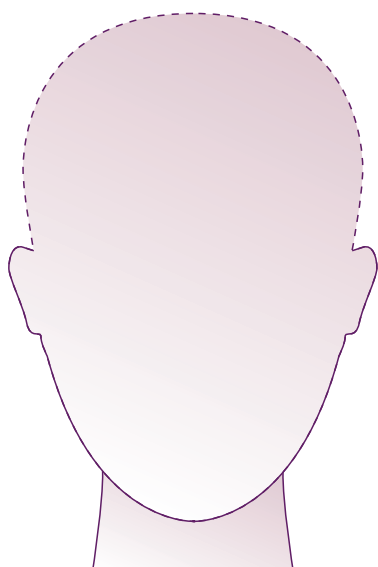

Directional Barcoding

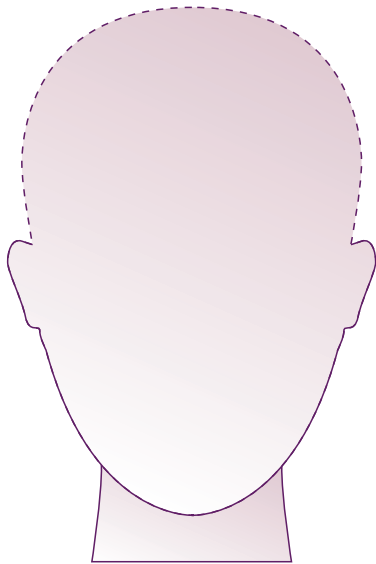

or underneath
one block colour

cresent sectioning (fine)

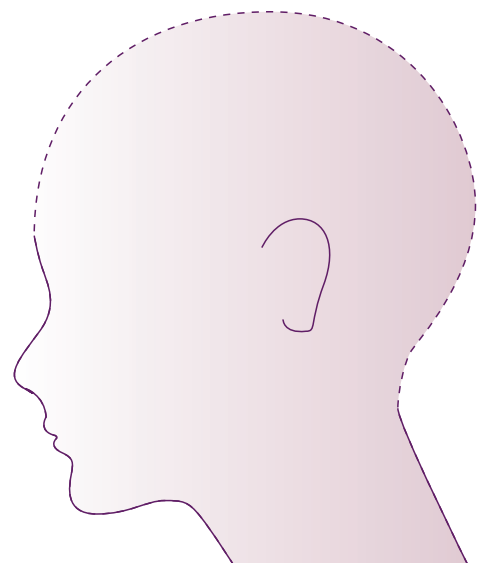
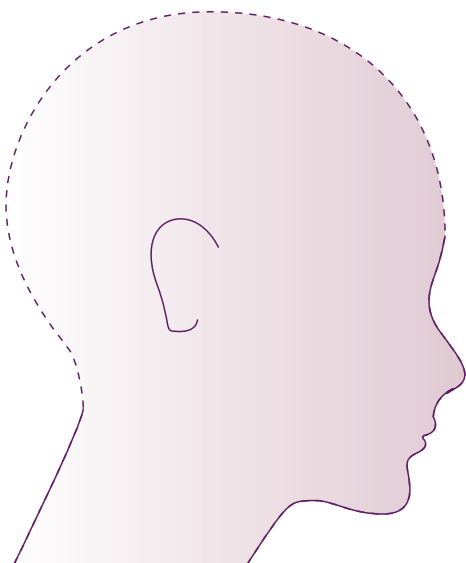
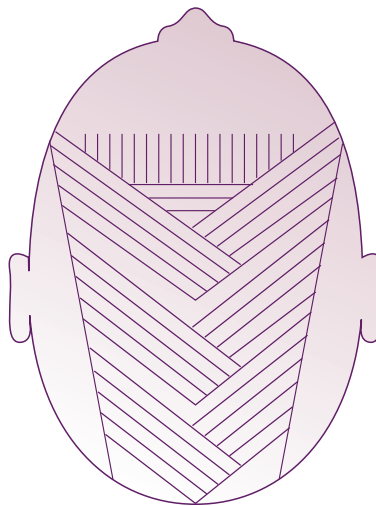
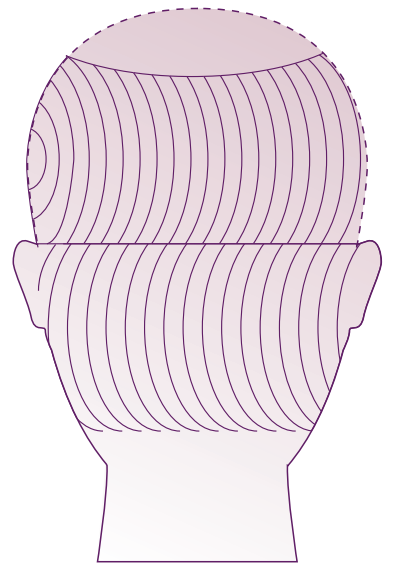

Francesco
GROUP

beautiful **hair**

www.francescogroup.co.uk